

MC33765

Very Low Dropout/Ultra Low Noise 5 Outputs Voltage Regulator

The MC33765 is an ultra low noise, very low dropout voltage regulator with five independent outputs which is available in TSSOP-16 surface mount package.

The MC33765 is available in 2.8 V. The output voltage is the same for all five outputs but each output is capable of supplying different currents up to 150 mA for output 4. The device features a very low dropout voltage (0.11 V typical for maximum output current), very low quiescent current (5.0 μ A maximum in OFF mode, 130 μ A typical in ON mode) and one of the output (output 3) exhibits a very low noise level which allows the driving of noise sensitive circuitry. Internal current and thermal limiting protections are provided.

Additionally, the MC33765 has an independent Enable input pin for each output. It includes also a common Enable pin to shutdown the complete circuit when not used. *The Common Enable pin has the highest priority over the five independent Enable input pins.*

The voltage regulators VR1, VR2 and VR3 have a common input voltage pin V_{CC1} . The other voltage regulators VR4 and VR5 have a common input voltage pin V_{CC2} .

Features

- Five Independent Outputs at 2.8V Typical, Based Upon Voltage Version
- Internal Trimmed Voltage Reference
- V_{out} Tolerance $\pm 3.0\%$ over the Temperature Range -40°C to $+85^{\circ}\text{C}$
- Enable Input Pin (Logic-Controlled Shutdown) for Each of the Five Outputs
- Common Enable Pin to Shutdown the Whole Circuit
- Very Low Dropout Voltage (0.11 V Typical for Output 1, 2, 3 and 5; 0.17 V Typical for Output 4 at Maximum Current)
- Very Low Quiescent Current (Maximum 5.0 μ A in OFF Mode, 130 μ A Typical in ON Mode)
- Ultra Low Noise for VR3 (30 μ V RMS Max, 100 Hz $< f <$ 100 kHz)
- Internal Current and Thermal Limit
- 100 nF for VR1, VR2, VR4 and VR5 and 1.0 μ F for VR3 for Stability
- Supply Voltage Rejection: 60 dB (Typical) @ $f = 1.0$ kHz
- These are Pb-Free Devices*

MAXIMUM RATINGS

Rating	Symbol	Value	Unit
Power Supply Voltage	V_{CC}	5.3	V
Thermal Resistance Junction-to-Air	$R_{\theta JA}$	140	$^{\circ}\text{C}/\text{W}$
Operating Ambient Temperature	T_A	-40 to +85	$^{\circ}\text{C}$
Maximum Operating Junction Temperature	T_J	125	$^{\circ}\text{C}$
Maximum Junction Temperature	T_{Jmax}	150	$^{\circ}\text{C}$
Storage Temperature Range	T_{stg}	-60 to +150	$^{\circ}\text{C}$

Stresses exceeding Maximum Ratings may damage the device. Maximum Ratings are stress ratings only. Functional operation above the Recommended Operating Conditions is not implied. Extended exposure to stresses above the Recommended Operating Conditions may affect device reliability.

*For additional information on our Pb-Free strategy and soldering details, please download the ON Semiconductor Soldering and Mounting Techniques Reference Manual, SOLDERRM/D.



ON Semiconductor®

<http://onsemi.com>

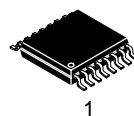

TSSOP-16
DTB SUFFIX
CASE 948F

MARKING DIAGRAM

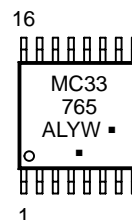

- A = Assembly Location
- L = Wafer Lot
- Y = Year
- W = Work Week
- = Pb-Free Package

(Note: Microdot may be in either location)

PIN CONNECTIONS

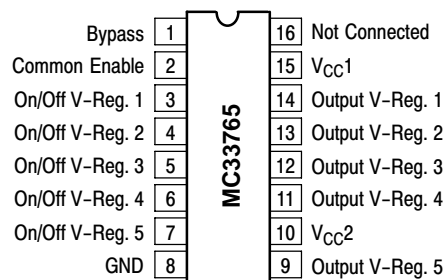

(Top View)

ORDERING INFORMATION

Device	Package*	Shipping†
MC33765DTB	TSSOP-16	96 Units/Rail
MC33765DTBG	TSSOP-16	96 Units/Rail
MC33765DTBR2	TSSOP-16	2500 Tape & Reel
MC33765DTBR2G	TSSOP-16	2500 Tape & Reel

*This package is inherently Pb-Free.

†For information on tape and reel specifications, including part orientation and tape sizes, please refer to our Tape and Reel Packaging Specifications Brochure, BRD8011/D.

MC33765

Simplified Block Diagram

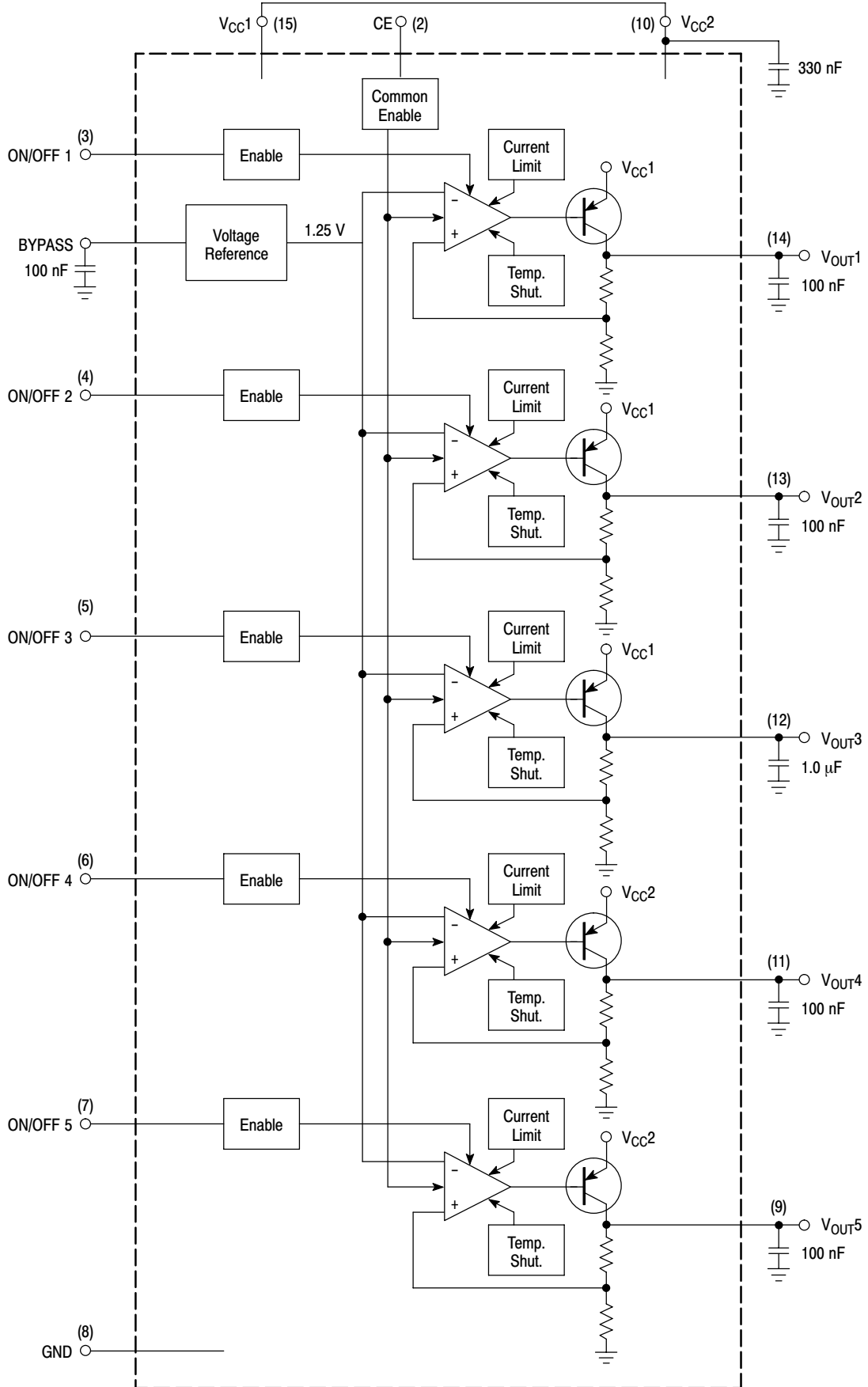

MC33765

CONTROL ELECTRICAL CHARACTERISTICS

ELECTRICAL CHARACTERISTICS (For typical values $T_A = 25^\circ\text{C}$, for min/max values $T_A = -40^\circ\text{C}$ to $+85^\circ\text{C}$ / Max $T_J = 125^\circ\text{C}$)

Characteristics	Symbol	Pin #	Min	Typ	Max	Unit
-----------------	--------	-------	-----	-----	-----	------

INDEPENDENT ENABLE PINS

Input Voltage Range	$V_{\text{ON/OFF}(1-5)}$	–	0	–	V_{CC}	V
Control Input Impedance		–	100	–	–	k Ω
Logic “0”, i.e. OFF State Logic “1”, i.e. ON State	$V_{\text{ON/OFF}(1-5)}$	–	– 2.0	– –	0.5 –	V

COMMON ENABLE PIN

Input Voltage Range	V_{CE}	2	0	–	V_{CC}	V
Control Input Impedance		2	100	–	–	k Ω
Logic “0”, i.e. OFF State Logic “1”, i.e. ON State	V_{CE}	2	– 2.0	– –	0.3 –	V

CURRENT CONSUMPTION WITH NO LOAD

Current Consumption at Logic “0” for the complete device, i.e. Common Enable and All Independent Enable pins at OFF State	I_{QOFF}	–	–	–	5.0	μA
Current Consumption at Logic “1” for the complete device, i.e. Common Enable and All Independents Enable pins at ON State	I_{QON1}	–	–	470	–	μA
Current Consumption at Logic “1”, Common Enable at ON State and All Independents Enable pins at OFF State	I_{QON2}	–	–	130	–	μA

SUPPLY AND OUTPUT VOLTAGES, DROPOUT AND LOAD REGULATION

Supply Voltage V_{CC}	MC33765 (2.8V)	$V_{\text{CC1}}, V_{\text{CC2}}$	15, 10	3.0	3.6	5.3	V
Regulator Output Voltage for VR1, VR2, VR3, VR4 and VR5 MC33765 (2.8V)		$V_{\text{OUT}(1-5)}$	14, 13, 12, 11, 9	2.7	2.8	2.85	V
Dropout Voltage for VR1, VR2, VR3, VR5 (Note 1)		$V_{\text{CC}} - V_{\text{OUT}}$	14, 13, 12, 9	–	0.11	0.17	V
Dropout Voltage for VR4 (Note 1)		$V_{\text{CC}} - V_{\text{OUT4}}$	11	–	0.17	0.30	V
Load Regulation ($T_A = 25^\circ\text{C}$)		$\text{Reg}_{\text{load}(1-5)}$	9, 11, 12, 13, 14	–	–	0.5	mV/mA

MAX POWER DISSIPATION AND TOTAL DC OUTPUT CURRENT (VR1 + VR2 + VR3 + VR4 + VR5) (Note 2)

Max Power Dissipation at $V_{\text{CC}} = 5.3\text{ V}$ ($T_A = 85^\circ\text{C}$) Max. Total RMS Output Current at $V_{\text{CC}} = 5.3\text{ V}$ ($T_A = 85^\circ\text{C}$)	P_{dmax} I_{RMS}	–	–	–	–	285 130	mW mA
Max Power Dissipation at $V_{\text{CC}} = 5.3\text{ V}$ ($T_A = 25^\circ\text{C}$) Max. Total RMS Output Current at $V_{\text{CC}} = 5.3\text{ V}$ ($T_A = 25^\circ\text{C}$)	P_{dmax} I_{RMS}	–	–	–	–	700 250	mW mA

- Typical dropout voltages have been measured at currents: Output1: 25 mA, Output2: 35 mA, Output3: 40 mA, Output4: 140 mA, Output5: 40 mA
Maximum value of dropout voltages are measured at maximum specified current.
- See package power dissipation and thermal protection.

MC33765

REGULATOR ELECTRICAL CHARACTERISTICS

ELECTRICAL CHARACTERISTICS (For typical values $T_A = 25^\circ\text{C}$, for min/max values $T_A = -40^\circ\text{C}$ to $+85^\circ\text{C}$ / Max $T_J = 125^\circ\text{C}$)

Characteristics	Pin #	Symbol	Min	Typ	Max	Unit
-----------------	-------	--------	-----	-----	-----	------

OUTPUT CURRENTS (Note 3)

Regulator VR1 Output Current	14	I_{OUT1}	10	–	30	mA
Regulator VR2 Output Current	13	I_{OUT2}	10	–	40	mA
Regulator VR3 Output Current	12	I_{OUT3}	0	–	50	mA
Regulator VR4 Output Current	11	I_{OUT4}	10	–	150	mA
Regulator VR5 Output Current	9	I_{OUT5}	10	–	60	mA
Current Limit for VR1, VR2, VR3, VR4, VR5 [Twice the max Output Current for each output]	14, 13, 12, 11, 9	I_{MAX}	–	$2 \times I_{OUT}$ (1–5)	–	mA

EXTERNAL CAPACITORS

External Compensation Capacitors for VR1, VR2, VR4, VR5	14, 13, 11, 9	$C_{(1-2, 4-5)}$	0.10	–	1.0	μF
External Compensation Capacitors for VR3	12	C_4	1.0	–	–	μF
External Compensation Capacitors ESR	–	–	0.05	1.0	3.0	Ω

RIPPLE REJECTIONS

Ripple Rejection VR1, VR2, VR4, VR5 (at Max. Current, 1.0 kHz, C = 100 nF)	14, 13, 11, 9	$\frac{(\Delta V_{OUT})}{(\Delta V_{CC})}$	50	60	–	dB
Ripple Rejection VR1, VR2, VR4, VR5 (at Max. Current, f = 10 kHz, C = 100 nF)	14, 13, 11, 9	$\frac{(\Delta V_{OUT})}{(\Delta V_{CC})}$	40	45	–	dB
Ripple Rejection of VR3 (at Max. Current, f = 1.0 kHz, C = 1.0 μF)	12	$\frac{(\Delta V_{OUT})}{(\Delta V_{CC})}$	50	60	–	dB
Ripple Rejection of VR3 (at Max. Current, f = 10 kHz, C = 1.0 μF)	12	$\frac{(\Delta V_{OUT})}{(\Delta V_{CC})}$	40	45	–	dB
Ripple Rejection of VR3 (at Max. Current, f = 100 kHz, C = 1.0 μF)	12	$\frac{(\Delta V_{OUT})}{(\Delta V_{CC})}$	18	22	–	dB

DYNAMIC PARAMETERS

Rise Time (1% → 99%) Common Enable at ON state, $C_{bypass} = 10$ nF, I_{out} at max. current VR1, VR2, VR4, VR5 with $C_{OUT} = 100$ nF, $T_A = 25^\circ\text{C}$ VR3 with $C_{OUT} = 1.0$ μF , $T_A = 25^\circ\text{C}$	t_{on}	–	–	30 150	μs μs
Fall Time (99% → 1%) [$C_{OUT} = 100$ nF, $I_{OUT} = 30$ mA] (Note 4)	t_{off}	–	100	–	μs
Overshoot ($C_{OUT} = 100$ nF for VR1, VR2, VR4, VR5 and $C_{OUT} = 1.0$ μF for VR3) at $T_A = 25^\circ\text{C}$ Common Enable at ON state, independent enable from OFF to ON state	–	–	5	8	%
Settling Time (to $\pm 0.1\%$ of nominal) at $T_A = 25^\circ\text{C}$ Common Enable at ON state, independent enable from OFF to ON state	–	–	95	–	μs

NOISE AND CROSSTALKS

Noise Voltage (100 Hz < f < 100 kHz) with $C_{bypass} = 100$ nF VR1, VR2, VR4, VR5 with $C_{OUT} = 100$ nF; VR3 with $C_{OUT} = 1.0$ μF	–	–	40 25	– 30	$\mu\text{V RMS}$
Static crosstalk (DC shift) between the Regulator Output, $T_A = 25^\circ\text{C}$ (Note 5)	–	–	150	200	μV
Dynamic CrossTalk Attenuation between the Regulator Outputs (f = 10 kHz), $T_A = 25^\circ\text{C}$ (Note 6)	–	30	35	–	dB

THERMAL SHUTDOWN

Thermal Shutdown	–	–	160	–	$^\circ\text{C}$
------------------	---	---	-----	---	------------------

- Maximum Output Currents are peak values. Total DC current have to be set upon maximum power dissipation specification. Only Output 3 has been designed to be stable at minimum current of 0 mA.
- The Fall time is highly dependent on the load conditions, i.e. load current for a specified value of C_{OUT} .
- Static Crosstalk is a DC shift caused by switching ON one of the outputs through independent enable to all other outputs. This parameter is highly dependent on overall PCB layout and requires the implementation of low-noise GROUND rules (e.g. Ground plane).
- Dynamic crosstalk is the ratio between a forced output signal to signal transferred to other outputs. This requires special device configuration to be measured.

MC33765

MC33765 TYPICAL OSCILLOSCOPE SHOTS

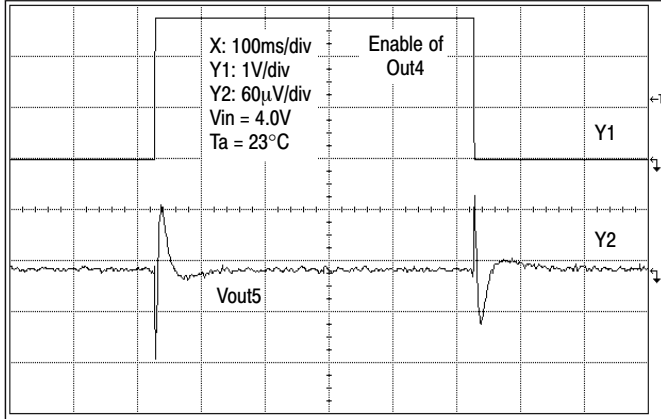

**Figure 1. Crosstalk response of MC33765 showing extremely weak interaction between outputs
Output 4 is banded from 0 to 150mA**

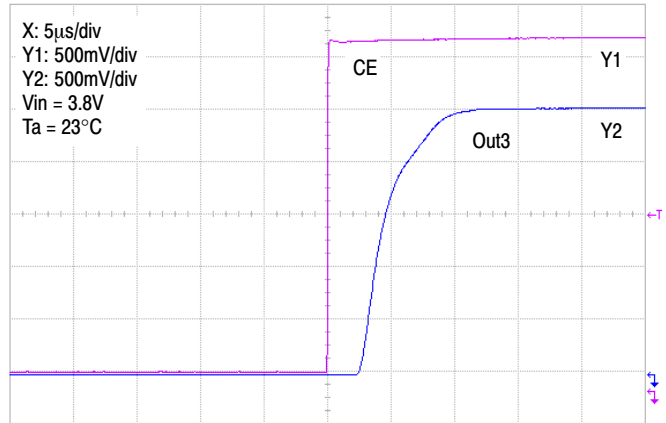

Figure 2. Repetitive Common Enable response time

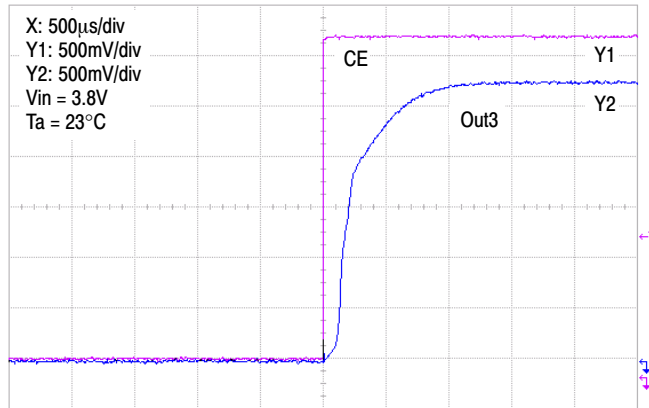

Figure 3. Single Common Enable response time (Cbypass discharged)

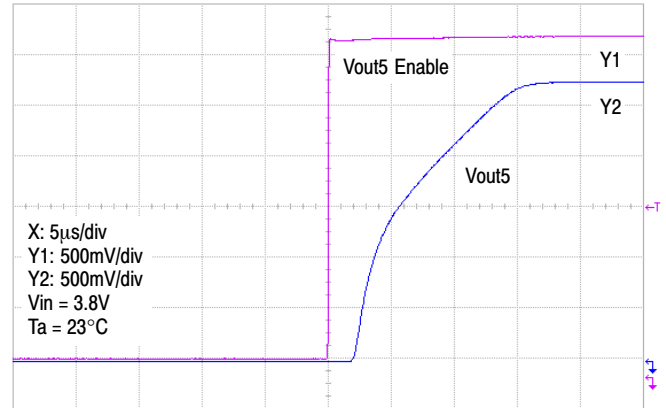

Figure 4. Output response from separate Enable

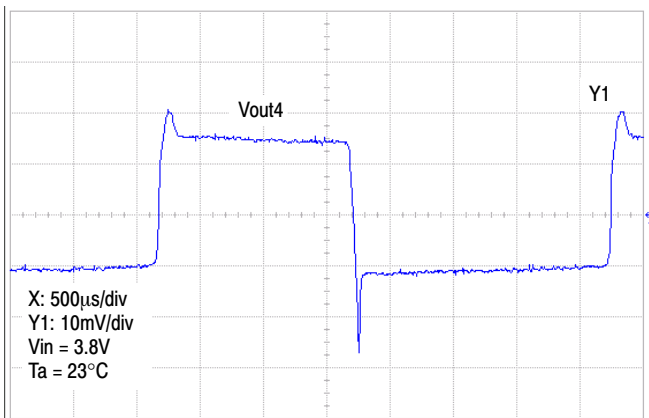

Figure 5. Output 4 is banded from 3mA to 150mA

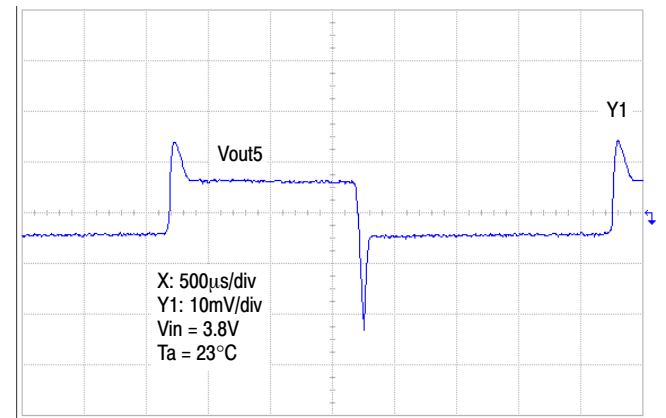

Figure 6. Output 5 is banded from 3mA to 50mA

MC33765

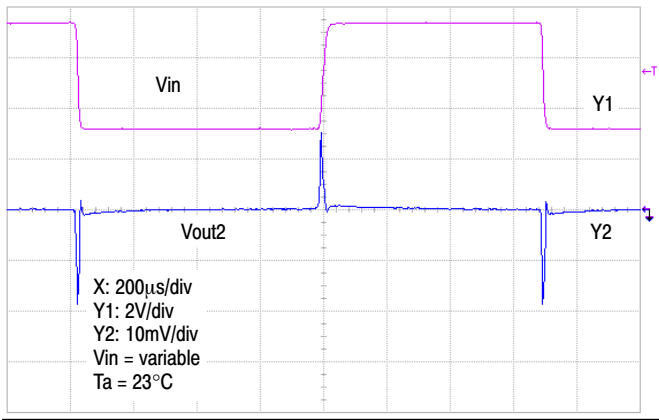

Figure 7. Typical input voltage rejection ($C_{out} = 100nF$)

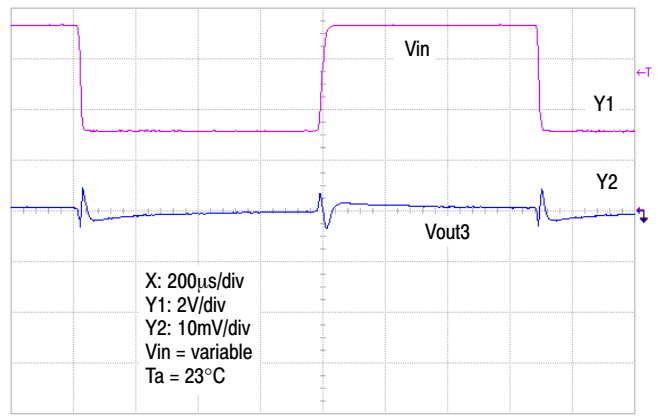

Figure 8. Typical input voltage rejection ($C_{out} = 1\mu F$)

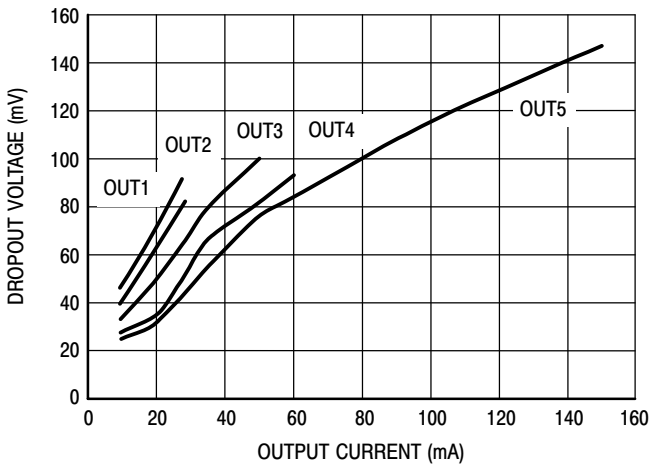

Figure 9. Dropout Voltage versus Output Current

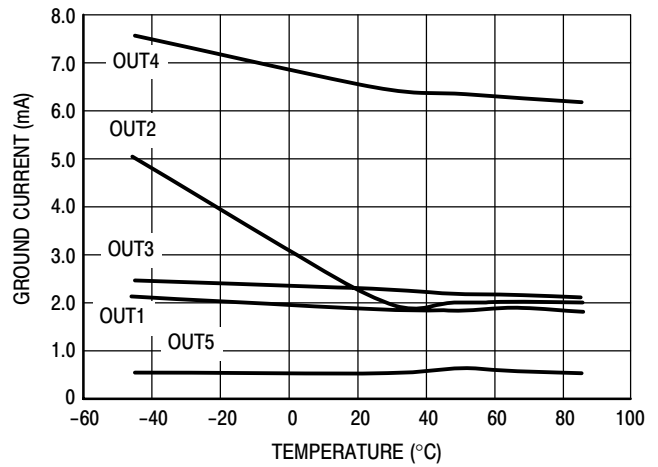

Figure 10. Ground Current versus Individual Output

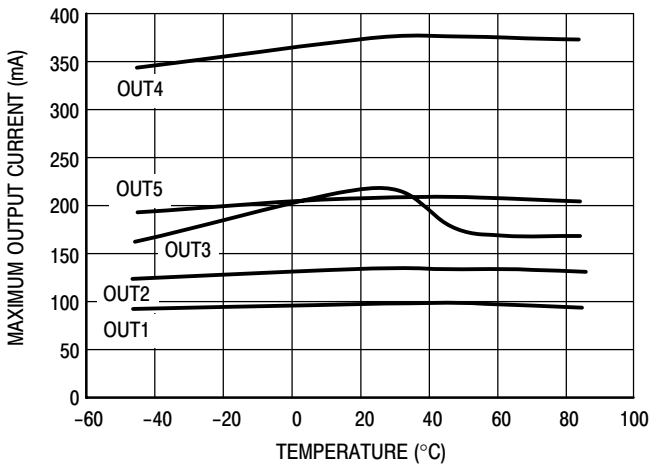

Figure 11. Maximum Output Current versus Temperature

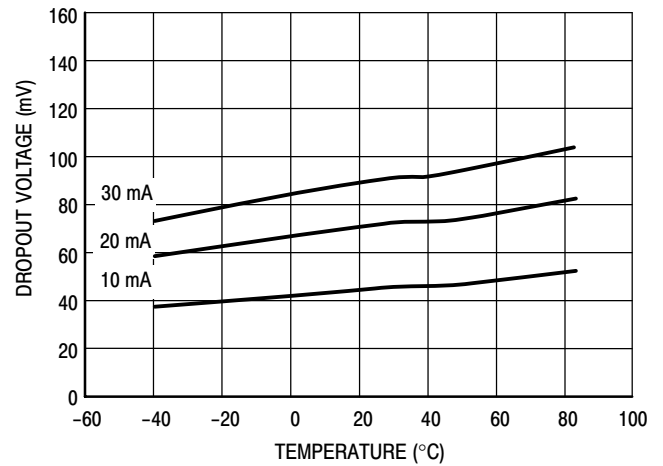

Figure 12. Dropout Voltage versus Operating Temperature: OUT1

MC33765

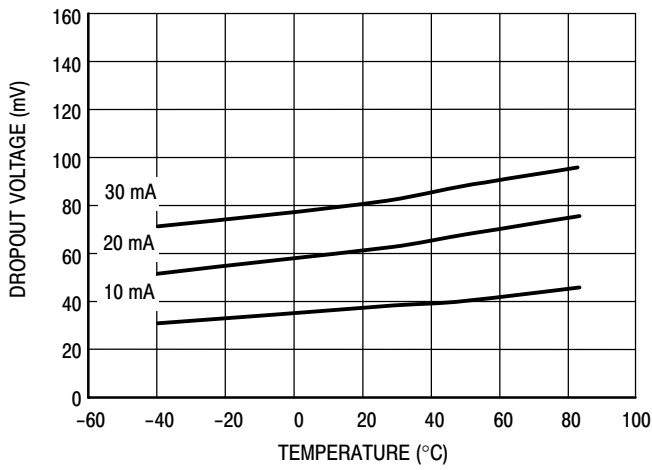

Figure 13. Dropout Voltage versus Operating Temperature: OUT2

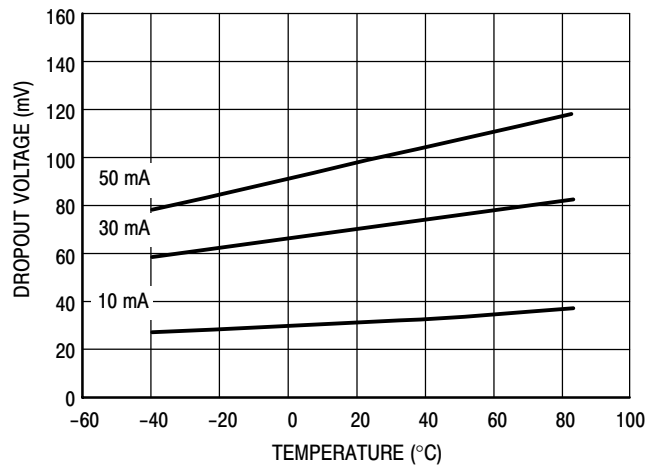

Figure 14. Dropout Voltage versus Operating Temperature: OUT3

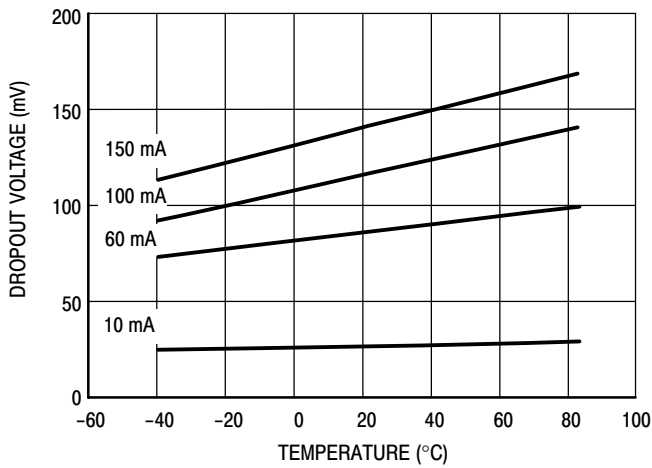

Figure 15. Dropout Voltage versus Operating Temperature: OUT4

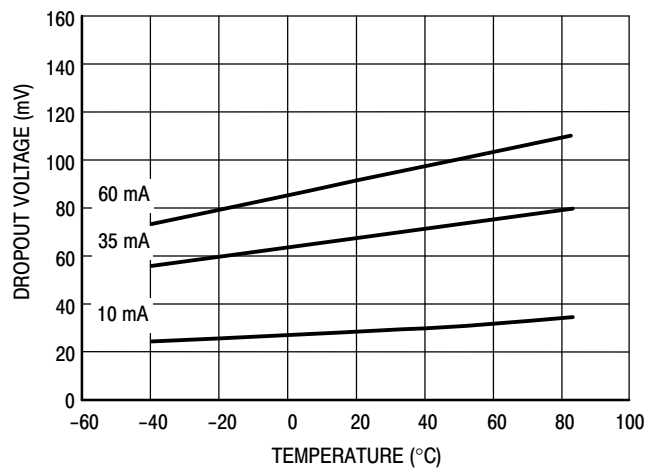

Figure 16. Dropout Voltage versus Operating Temperature: OUT5

DEFINITIONS

Load Regulation – The change in output voltage for a change in load current at constant chip temperature.

Dropout Voltage – The input/output differential at which the regulator output no longer maintains regulation against further reductions in input voltage. Measured when the output drops 100 mV below its nominal value (which is measured at 1.0 V differential input/output), dropout voltage is affected by junction temperature, load current and minimum input supply requirements.

Output Noise Voltage – The RMS AC voltage at the output with a constant load and no input ripple, measured over a specified frequency range.

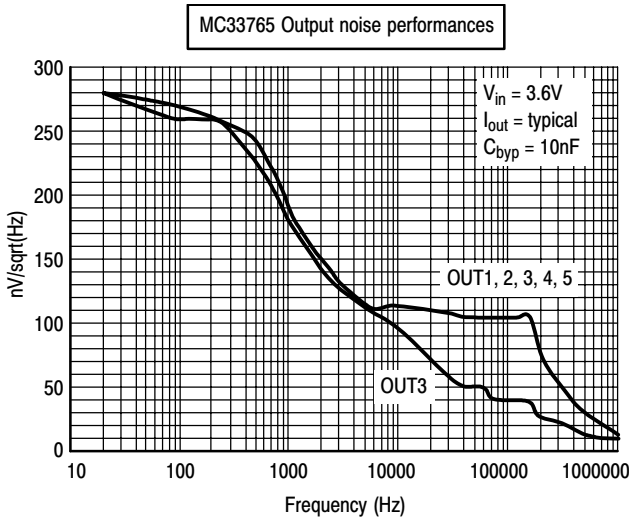

Maximum Power Dissipation – The maximum total dissipation for which the regulator will operate within specifications.

Quiescent Current – Current which is used to operate the regulator chip with no load current.

Line Regulation – The change in input voltage for a change in the input voltage. The measurement is made under conditions of low dissipation or by using pulse techniques such that the average chip temperature is not significantly affected.

Thermal Protection – Internal thermal shutdown circuitry is provided to protect the integrated circuit in the event that the maximum junction temperature is exceeded. When activated, typically 160°C, the regulator turns off. This feature is provided to prevent catastrophic failures from accidental overheating.

Maximum Package Power Dissipation and RMS Current – The maximum package power dissipation is the power dissipation level at which the junction temperature reaches its maximum value i.e. 125°C. The junction temperature is rising while the difference between the input power ($V_{CC} \times I_{CC}$) and the output power ($V_{out} \times I_{out}$) is increasing.

As MC33765 device exhibits five independent outputs I_{out} is specified as the maximum RMS current combination of the five output currents.

As the device can be switched ON/OFF through independent Enable (ON/OFF pin) or Common Enable, the output signal could be, for example, a square wave. Let's assume that the device is ON during T_{ON} on a signal period T . The RMS current will be given by:

$$I_{out_{RMS}} = I_P \times \sqrt{D}$$

where $D = \frac{T_{ON}}{T}$

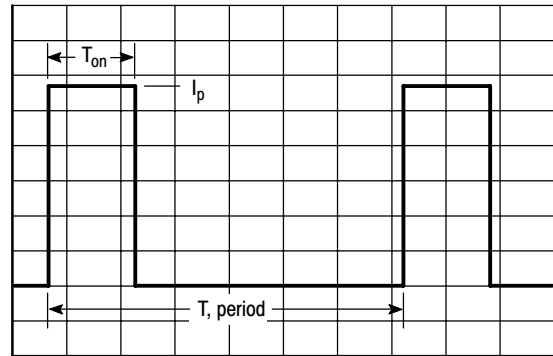

Depending on ambient temperature, it is possible to calculate the maximum power dissipation and so the maximum RMS current as following:

$$P_d = \frac{T_J - T_A}{R_{\theta JA}}$$

The maximum operating junction temperature T_J is specified at 125°C, if $T_A = 25^\circ C$, then $P_D = 700 \text{ mW}$. By neglecting the quiescent current, the maximum power dissipation can be expressed as:

$$I_{out} = \frac{P_D}{V_{CC} - V_{out}}$$

So that in the more drastic conditions:

$V_{CC} = 5.3 \text{ V}$, $V_{out} = 2.7 \text{ V}$ then the maximum RMS value of I_{out} is 269 mA.

The maximum power dissipation supported by the device is a lot increased when using appropriate application design. Mounting pad configuration on the PCB, the board material and also the ambient temperature are affected the rate of temperature rise. It means that when the I_C has good thermal conductivity through PCB, the junction temperature will be "low" even if the power dissipation is great.

The thermal resistance of the whole circuit can be evaluated by deliberately activating the thermal shutdown of the circuit (by increasing the output current or raising the input voltage for example).

Then you can calculate the power dissipation by subtracting the output power from the input power. All variables are then well known: power dissipation, thermal shutdown temperature (160°C for MC33765) and ambient temperature.

$$R_{\theta JA} = \frac{T_J - T_A}{P_D}$$

MC33765

DESIGN HINTS

Reducing the cross-talk between the MC33765 outputs

One of the origin of the DC shift finds its seat in the layout surrounding the integrated circuit. Particular care has to be taken when routing the output ground paths. Star grounding

or a ground plane are the absolute conditions to reduce the noise or shift associated to common impedance situations, as depicted by Figure 17.

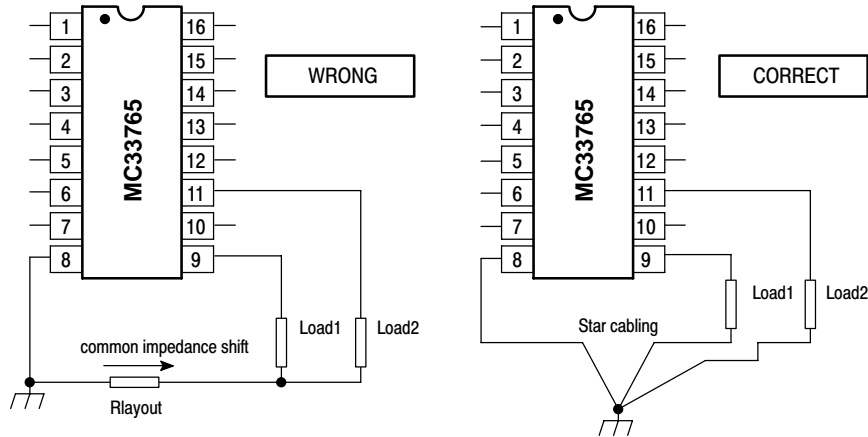

Figure 17. Star Cabling Avoids Coupling by Common Ground Impedance

The first left cabling will generate a voltage shift which will superimpose on the output voltages, thus creating an undesirable offset. By routing the return grounds to a single

low impedance point, you naturally shield the circuit against common impedance disturbances. Figure 18 portraits the text fixture implemented to test the response of the MC33765.

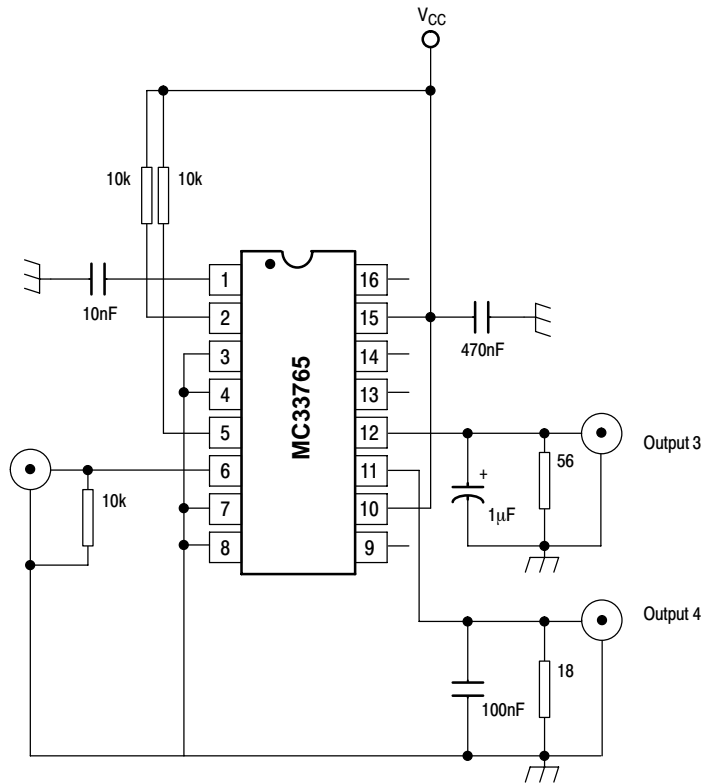

Figure 18. DC Shift Text Fixture

MC33765

DESIGN HINTS (cont.)

Output 4 was banded from 0 to 150mA via its dedicated control pin, while output 3 fixed at 50mA was monitored. The circuit has been implemented on a PCB equipped with a

ground plane and routed with short copper traces. The results are shown hereafter, revealing the excellent behavior of the MC33765 when crosstalks outputs is at utmost importance.

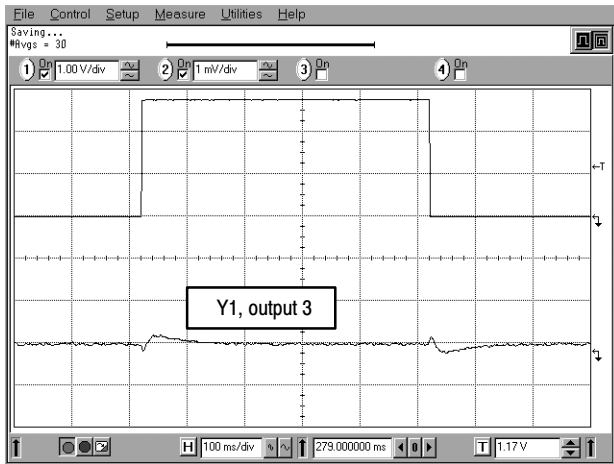

Figure 19. $V_{in} = 4V$, $Y1 = 62.5\mu V/div$, $F = 200Hz$

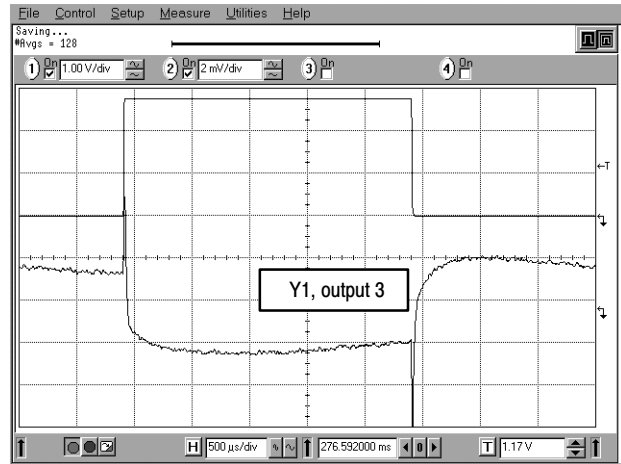

Figure 20. $V_{in} = 5V$, $Y1 = 1mV/div$

TECHNICAL TERMS

Rise Time – Common Enable being in ON state, the device is switched on by ON/OFF pin control.

Let's call t_1 the time when ON/OFF signal reaches 1% of its nominal value.

Let's call t_2 the time when output signal reaches 99% of its nominal value.

The rise time for this device is specified as:

$$t_{ON} = t_1 - t_2$$

Fall Time – The fall time is highly dependent on the output capacitor and so device design is not impacting at all this parameter.

Overshoot, Settling Time – As regulators are based on regulation loop through an error amplifier, this type of device requires a certain time to stabilize and reach its nominal value.

The overshoot is defined as the voltage difference between the peak voltage and steady state when switching ON the regulator.

The settling time is equal to the time required by the regulator to stabilize to its nominal value ($\pm 0.5\%$) after peak value when switching ON the regulator.

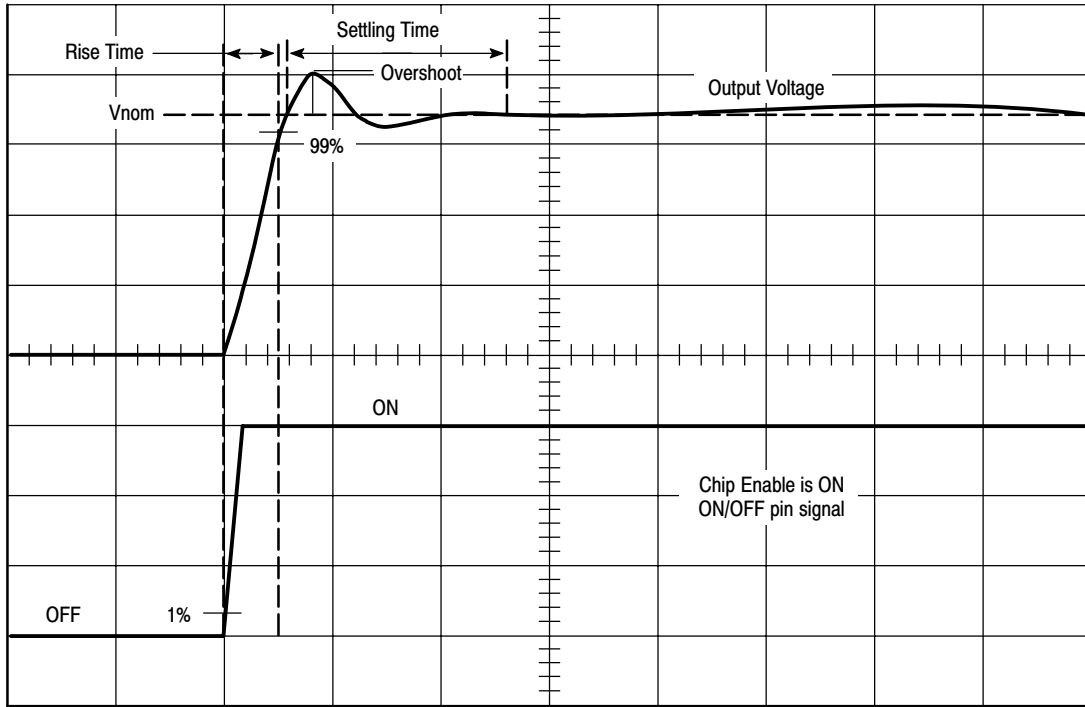

MC33765

PACKAGE DIMENSIONS

TSSOP-16
CASE 948F-01
ISSUE A

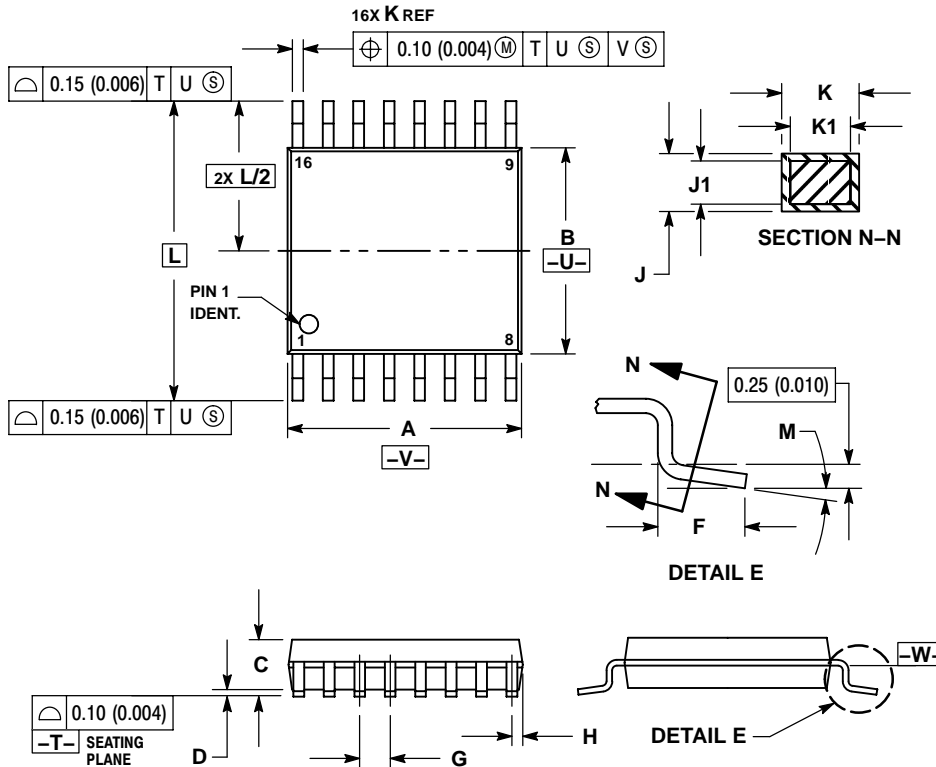

NOTES:

1. DIMENSIONING AND TOLERANCING PER ANSI Y14.5M, 1982.
2. CONTROLLING DIMENSION: MILLIMETER.
3. DIMENSION A DOES NOT INCLUDE MOLD FLASH. PROTRUSIONS OR GATE BURRS SHALL NOT EXCEED 0.15 (0.006) PER SIDE.
4. DIMENSION B DOES NOT INCLUDE INTERLEAD FLASH OR PROTRUSION. INTERLEAD FLASH OR PROTRUSION SHALL NOT EXCEED 0.25 (0.010) PER SIDE.
5. DIMENSION K DOES NOT INCLUDE DAMBAR PROTRUSION. ALLOWABLE DAMBAR PROTRUSION SHALL BE 0.08 (0.003) TOTAL IN EXCESS OF THE K DIMENSION AT MAXIMUM MATERIAL CONDITION.
6. TERMINAL NUMBERS ARE SHOWN FOR REFERENCE ONLY.
7. DIMENSION A AND B ARE TO BE DETERMINED AT DATUM PLANE -W-.

DIM	MILLIMETERS		INCHES	
	MIN	MAX	MIN	MAX
A	4.90	5.10	0.193	0.200
B	4.30	4.50	0.169	0.177
C	---	1.20	---	0.047
D	0.05	0.15	0.002	0.006
F	0.50	0.75	0.020	0.030
G	0.65 BSC		0.026 BSC	
H	0.18	0.28	0.007	0.011
J	0.09	0.20	0.004	0.008
J1	0.09	0.16	0.004	0.006
K	0.19	0.30	0.007	0.012
K1	0.19	0.25	0.007	0.010
L	6.40 BSC		0.252 BSC	
M	0°	8°	0°	8°

ON Semiconductor and are registered trademarks of Semiconductor Components Industries, LLC (SCILLC). SCILLC reserves the right to make changes without further notice to any products herein. SCILLC makes no warranty, representation or guarantee regarding the suitability of its products for any particular purpose, nor does SCILLC assume any liability arising out of the application or use of any product or circuit, and specifically disclaims any and all liability, including without limitation special, consequential or incidental damages. "Typical" parameters which may be provided in SCILLC data sheets and/or specifications can and do vary in different applications and actual performance may vary over time. All operating parameters, including "Typicals" must be validated for each customer application by customer's technical experts. SCILLC does not convey any license under its patent rights nor the rights of others. SCILLC products are not designed, intended, or authorized for use as components in systems intended for surgical implant into the body, or other applications intended to support or sustain life, or for any other application in which the failure of the SCILLC product could create a situation where personal injury or death may occur. Should Buyer purchase or use SCILLC products for any such unintended or unauthorized application, Buyer shall indemnify and hold SCILLC and its officers, employees, subsidiaries, affiliates, and distributors harmless against all claims, costs, damages, and expenses, and reasonable attorney fees arising out of, directly or indirectly, any claim of personal injury or death associated with such unintended or unauthorized use, even if such claim alleges that SCILLC was negligent regarding the design or manufacture of the part. SCILLC is an Equal Opportunity/Affirmative Action Employer. This literature is subject to all applicable copyright laws and is not for resale in any manner.

PUBLICATION ORDERING INFORMATION

LITERATURE FULFILLMENT:
Literature Distribution Center for ON Semiconductor
P.O. Box 5163, Denver, Colorado 80217 USA
Phone: 303-675-2175 or 800-344-3860 Toll Free USA/Canada
Fax: 303-675-2176 or 800-344-3867 Toll Free USA/Canada
Email: orderlit@onsemi.com

N. American Technical Support: 800-282-9855 Toll Free
USA/Canada
Europe, Middle East and Africa Technical Support:
Phone: 421 33 790 2910
Japan Customer Focus Center
Phone: 81-3-5773-3850

ON Semiconductor Website: www.onsemi.com
Order Literature: <http://www.onsemi.com/orderlit>

For additional information, please contact your local Sales Representative